

Cable Locator User Manual

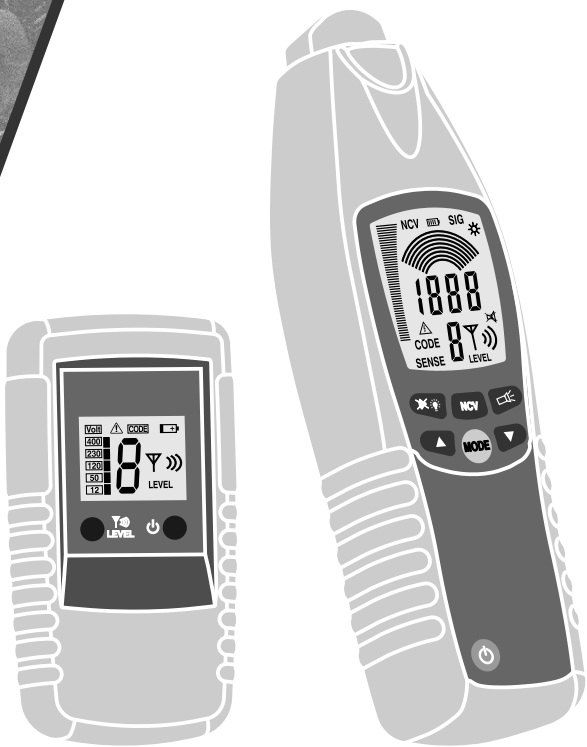





**Please read this manual before switching the unit on.
Important safety information inside.**

Contents









	Page
1 International Safety Information	2
2 General Description	3
2.1 Features	3
2.2 Function description	4
2.3 Cable Locator Mode	6
2.4 Specification	7
3 Operating Principle	8
3.1 Locator in complete circuits	8
3.2 One pole application(In open circuits)	9
3.3 Double pole application(In complete circuits)	9
3.4 Locating and tracing of lines, lateral circuit branches, sockets, switches and junctions in house installations circuits (one-pole application)	10
3.5 Locating of line interruptions in the plastic-sheathed cable (one-pole application)	11
3.6 Locating of line interruptions using two transmitters(one-pole application)	12
3.7 Error detection for a electrical floor heating (one-pole application)	13
3.8 Locating of bottlenecks (obstructions) in installation pipes (single-pole application)	13
3.9 Locating Fuses (dual-pole application)	14
3.10 Locating of short-circuits in conductors (doubel-pole applicaion)	15
3.11 Tracing installed water and heating pipes (one-pole application)	16
3.12 Detedting the direction of water and heating pipes already installed (one-pole application)	16
3.13 Locating a complete house wiring (one-pole application)	17
3.14 Following lines with higher location depth (dual-pole application)	18
3.15 Tracing Conductors Within the soil (single-pole application)	19
3.16 The reach will be improved when seeking the tension	20
3.17 Sorting or determination of conductors already installed (double-pole application)	21
3.18 Mains Voltage Detection Locating Line Interruptions	21
3.19 Setting the Codes	22
3.20 Important Application	22
4 Measurement Point Illumination	23
5 Maintenance	23
6 Battery Replacement	24

1 International Safety Symbols

-  Warning: This symbol indicates that the operator must refer to an explanation in the user manual to avoid personal injury or damage to the meter.
-  Caution! Risk of electric shock
-  Reference. Please use utmost attention.
-  Comply with EMC.

1.1 Safety Information

Read the user manual carefully before attempting to operate or service the meter.

-  The respective accident prevention regulations established by the associations for electrical systems and equipment must be strictly met at all times.
-  This WARNING symbol indicates a potentially hazardous situation, which if not avoided, could result in death or serious injury, or result damage to the product.
-  This symbol advises the user that the terminal(s) so marked must not be connected to a circuit point at which the voltage with respect to earth ground exceeds (in this case)300 VAC or VDC.
-  Prior to any operation, ensure that connecting leads used and electronic load are in perfect condition.
-  If the operator's safety cannot be guaranteed, the instrument must be removed from service and protected against use.
-  The Cable Locator may only be used on systems complying with the nominal voltages indicated in the technical data section.
-  Prior to usage ensure perfect instrument function: we recommend to exclusively connect the transmitter from the phase towards the neutral conductor.
-  If the RCD trips when connecting the sender, a fault current is already active within the installation.
-  If the instrument is subjected to an extremely high electro-magnetic field, its functioning ability may be impaired.

⚠ The safety can no longer be insured if the instrument:

- Shows obvious damage
- does not carry out the desired measurements
- has been stored for too long under unfavorable conditions
- has been subjected to mechanical stress during transport.

All relevant statutory regulations must be adhered to when using this instrument

2 General Description

The Cable Locator consists of a transmitter and a receiver, which is a portable measurement instrument and can be used to detect or trace conductors.

The signal generated by the transmitter is made of a modulated current, generating an electro-magnetic field around a conductor. This electro-magnetic field induces a voltage within the receiving coil. The induced voltage is amplified, decoded, and converted to the original signal by the receiver, and finally displayed on the screen. The connecting parameter for the transmitter during an application must be a closed current circuit.

2.1 Features:

- Finding conductors in walls, conductor interruptions, short-circuits in conductors
- Conductor tracing in the soil
- Detecting fuses and assigning current circuits
- Tracing sockets and distribution sockets having accidentally been covered by plastering
- Detecting interruptions and short-circuits in floor heating
- Tracing metallic water and heating piping
- All application areas (both, voltage-free and live) are performed without using any additional instruments
- Transmitter display indicates the transmission level, the transmission code, as well as the foreign voltage
- Receiver display indicates the reception level, the transmission code, as well as the mains voltage detection
- Automatic and manual sensitivity adjustment
- Acoustic reception signal may be switched off
- Auto-Power-Off function
- Backlight
- Additional lighting function when working under bad lighting conditions
- Additional transmitters are available to extend or distinguish several signals

2.2 Function description

Transmitter

- 1: Terminal “+”
- 2: Terminal “ground”
- 3: LCD
- 4: Key Sensitivity Level/Backlit
- 5: Power Button
- 6: Battery case

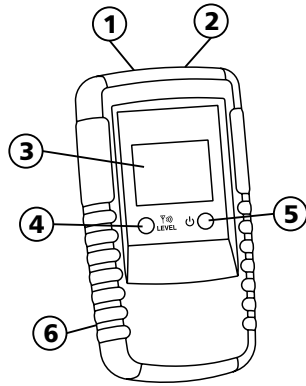

Transmitter - Display

- a: Transmitted Code (1,2,3,4,5,6,7)
- b: External voltage display
- c: External voltage detection (12V, 50V, 120V, 230V, 400V)
- d: Low battery indication
- e: Transmitted level display(I, II or III)

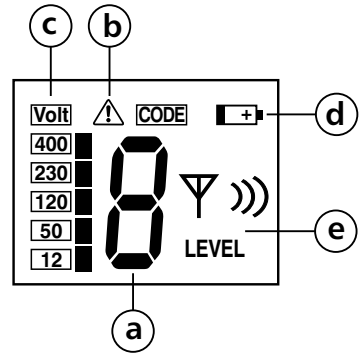

Transmitter Built-in Fuses

The built-in fuses protect the instrument against overload or faulty manipulation.

The built-in fuse may only be replaced by our factory service department.

Detecting that a fuse has tripped: The reason for the output signal generated by the transmitter being only weak could be that the fuse has tripped. To verify whether the fuse has tripped, please proceed as follows:

- Disconnect the transmitter from all connected measurement circuits.
- Switch on the transmitter.
- Set transmission level I.
- Perform a single-pole connection of one test lead to socket 1.
- Switch on the receiver. Search for the signal at the cable and place the sensor head on the cable.
- Insert the open cable end into connection socket 2.

Receiver

- 1: Sensor head
- 2: Flashlight
- 3: LCD display
- 4: NCV button (Non-contact voltage detection) to select between cable locator mode and mains voltage detection mode
- 5: Flashlight button
- 6: Downward selection
- 7: Mode button to selective automatic or manual mode
- 8: Backlight/Beeper ON/OFF button
- 9: Upward selection
- 10: Power ON/OFF button
- 11: Battery case

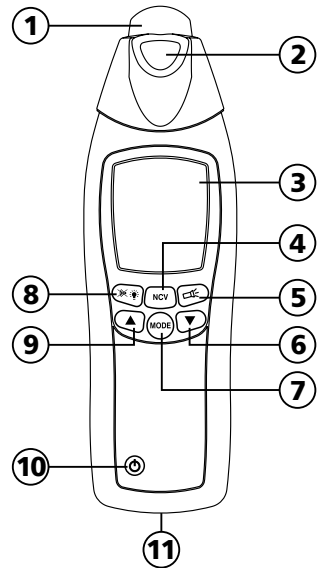

Receiver - Display

- a: The indication of the acoustic display switched off
- b: The active LCD illumination indicator
- c: Information transmitted by the transmitter (transmission code and battery charge condition)
- d: The indication of the automatic mode switched on
- e: The signal intensity indicator with bargraph
- f: Low battery indication
- g: Manual mode: additional graphic display to show the selected sensitivity Display of the sen-sitivity within the selective mode.
Large magnifying glass => high sensitivity,
Small magnifying glass => low sensitivity
- h: The manual mode active indicator
- i: Mains voltage display
- j: Automatic mode; digital display for signal intensity / manual mode.
- k: Transmission level transmitted by the transmitter (LEVEL I, II, or III)
- L: The indication of the mains voltage detection switched on

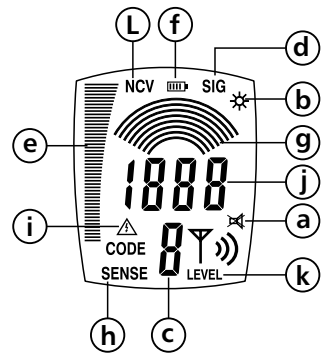

2.3 Cable Locator Mode

Automatic Mode

When the automatic mode is selected the symbol "SIG" is displayed.

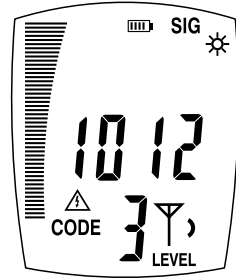

Automatic Mode

Manual Mode (Press the MODE button)

Select Manual mode by means of "downward selection ". When the manual mode is selected the symbol "SENSE" are displayed..

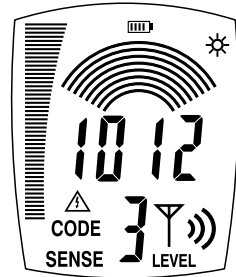

Manual Mode

AC NCV Detection Mode

When press NCV button, the flashlight will be active.

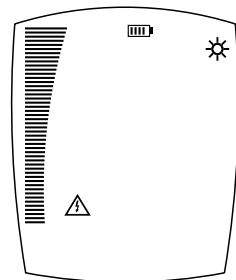

AC NCV Detection Mode

2.4 Specification

Transmitter:

Output signal	125kHz
External voltage detection	
Voltage Range	12...400V
Frequency Range	0...60Hz
Display	LCD display
External Voltage Detection	max. 400V AC/DC
Over Voltage Category	CAT III 300V
Pollution Degree	2
Auto Power Off	approx.1 hours (No any Operation)
Power Supply	One 9V battery , NEDA 1604, IE6F22.Power
Consumption	max. 18mA
Fuse	F0.5A 500V, 6.3 x 32 mm
Temperature Range (Work)	0...40°C, max 80% rel. humidity (not condens.)
Temperature Range (Storage)	-20...60°C, max 80% rel. humidity (not condens.)
Height above MSL	up to 2000meters
Dimensions	130 x 69 x 32mm
Weight	approx. 130g

Receiver:

Tracing depth	The tracing depth depends of medium and application
Cable Locator Mode	approx. 0...2meters (single-pole application)
	approx. 0...0.5meters (double-pole application)
Voltage detection	approx. 0...0.4meters
Display	LCD with functions- and bargraph
Power Supply	One 9V battery , NEDA 1604, IE6F22.Power
Consumption	approx. 23mA (without backlight or lamp)
	approx. 35mA (with backlight)
	max. 40mA (Backlight and lamp)
Auto Power Off	approx. 5minute (No any Operation)
Temperature Range (Work)	0...40°C, max 80% rel. humidity (not condens.)
Temperature Range (Storage)	-20...60°C, max 80% rel. humidity (not condens.)
Height above MSL	up to 2000meters.
Dimensions	192 x 61 x 37mm
Weight	approx. 180g

3 Operating Principle

The Cable Locator consists of a transmitter and a receiver. The signal generated by the transmitter consists of a modulated current. Generating a magnetic field around a conductor. See figure 1. This electro-magnetic field surrounding the conductor induces a voltage within the receiver coils. For both automatic and manual mode, the receiver works with three coils and does, not depend on a position. A selective and position-dependant search is performed in selective mode with only one active coil.

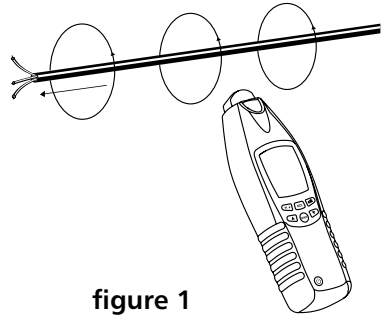

figure 1

3.1 Locator in complete circuits

One-pole application: Connect the transmitter to only one conductor (one pole application). In this operational mode, the transmitter is supplied by the built-in battery. Due to the high-frequency signal generated by the transmitter, only one single conductor can be located and traced. The second conductor is the ground. This arrangement causes a high frequency current to flow through the conductor and to be transmitted to ground, similar to a radio and receiver.

Double pole application: Connect the transmitter to the mains(double-pole application). The transmitter is supplied by the mains. In this example, the modulated current flows through the phase into the transformer and back through neutral. There is a further possibility for voltage free systems by connecting the transmitter to two line terminals while short-circuiting the other line ends. Thus a complete circuit is created. Then, the transmitter is supplied by the built-in battery.

Note: The Cable Locator can only detect or locate lines, which are connected correctly in accordance with the physical principle described.

3.2 One pole application(In open circuits)

Line interruptions in walls and floors. Finding and tracing of lines, sockets, junction box, switches, etc. for house installations. Finding bottlenecks, kinking and bucklings and obstructions in installation pipes by means of a metal coil.

The ground connector must be connected to a suitable earth. A typical example would be an earthed socket. The tracing depth amounts to 0...2 meters.

Note: The tracing depth depends on the medium and application.

3.3 Double pole application(In complete circuits)

When detecting short-circuits or during wire sorting, i.e circuits with or without voltage. Voltage –free circuits are directly supplied by the instrument battery. Example for a complete circuit: Complete circuits are appropriate for: i.e. detecting sockets, switches, etc in live installations.

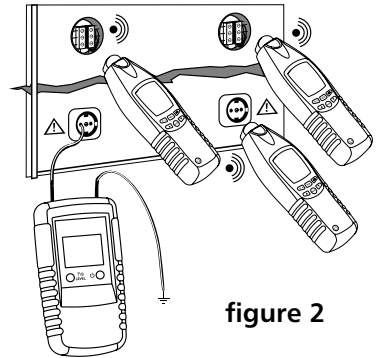

figure 2

Note:

The tracing depth amounts to 0...0.5 meters
The tracing depth depends of medium and application

When connecting in live circuits, safety regulations must be followed.

The switching with button 4 from LEVEL I to LEVEL III the sensitivity of Distance is increased up to factor 5.

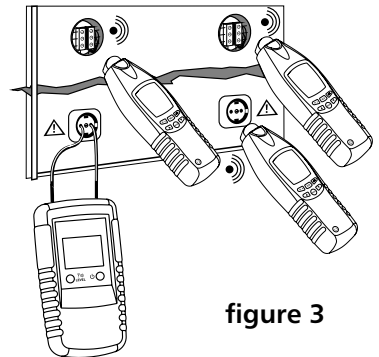

figure 3

3.4 Locating and tracing of lines, lateral circuit branches, sockets, switches and junctions in house installations circuits (one-pole application)

When locating and tracing of lines, sockets, switches and junctions in house installations circuits, the circuits must be dead; Neutral line and ground must be connected and fully operational; Connect transmitter to phase and neutral according to figure 4; and Carry out this example as described in the application example.

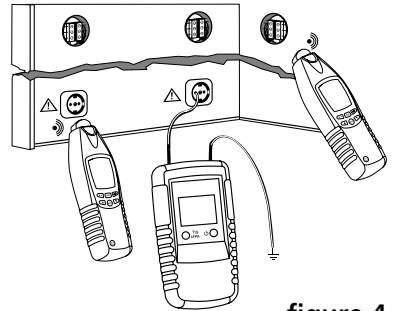

figure 4

Note:

If the supply cable fed with the signal via the transmitter is located, e.g. Directly in parallel to other conductors (e.g. cable duct), or if these conductors are crossed, the signal is also input into the other conductors. The fuse must be removed during this example.

The switching with button 4 from "LEVEL I" to "LEVEL III" the sensitivity of Distance is increased up to a factor of 5.

Setup: manual mode, minimal sensitivity. Tracing depth max. 2 meters.

3.5 Locating of line interruptions in the plastic-sheathed cable (one-pole application)

When locating of line interruptions, the circuit must be dead; All lines which are not required must be connected to the auxiliary ground in accordance with figure 8; Connect transmitter to one lead and to an neutral according to figure 5; and Carry out this example as described in the application example.

The ground connected to the transmitter should be earth from an earthed socket or a water pipe which is properly earthed. When tracing line interruptions in multicore cables, not that all remaining leads in plastic-sheathed cable or conductor must be grounded in accordance with the regulations. This is required to avoid crosscoupling of the fed signal (by a capacitive effect to the source terminals). The tracing depth for sheathed cable and conductors are different, as the individual leads in the sheathed cable are twisted around themselves. The transition resistance of a line interruption must be higher than 100 kOHM. The verification of resistance can be carried out by any multimeter.

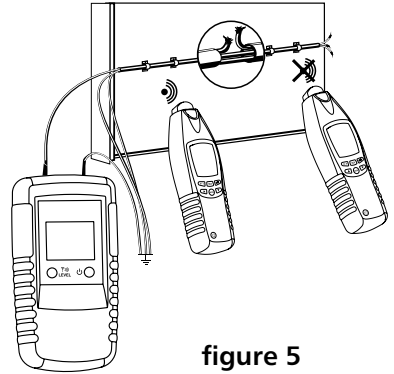

figure 5

Note:

The switching with button 4 from "LEVEL I" to "LEVEL III" the sensitivity of Distance is increased up to factor 5.

Tracing depth max. 2 meters.

Setup: manual mode, minimal sensitivity

3.6 Locating of line interruptions using two transmitters (one-pole application)

When locating a line interruption using one transmitter to feed from one conductor end, the location of interruptions may not be precisely located in case of bad conditions due to a field disturbance. The drawbacks described above can easily be avoided when using two transmitters (one from each end) for line interruption detection. In this instance, each of the transmitters are set to a different line code (e.g. transmitter one to code "1", the other transmitter to code "2"). A second transmitter with a different line code is not included within the scope of supply and, therefore, has to be ordered separately.

If the transmitters are connected in accordance with the figure 12, the receiver indicates "3" at the left side of the line interruption. If you continue further than the interruption, towards the right, the receiver displays "7". If you are directly above the interruption, no line code is displayed, due to the overlapping of both transmitter signals. The line interruption is located exactly in the middle between the displayed line codes "3" and "7".

Requirements:

- The current circuit must not be live.
- All lines not being used must be connected to the auxiliary ground as shown in the figure.
- Connect both transmitters as shown in the figure.
- Proceed as described in the application example.

The ground connected to the transmitter and to the wires not being used can be as follows is: an auxiliary ground, an orderly connected ground contact of a home office socket, or an orderly a grounded water pipe.

Please make sure during line interruption locating in multi-wire shielded conductors and cables, that all remaining wires are orderly grounded. This is required to avoid inductive disturbance (by capacity coupling).

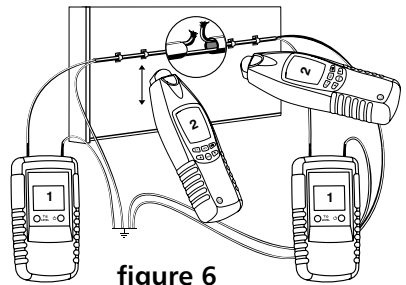

figure 6

The locating depth for shielded conductors and cables varies, as the individual wires within the shield are twisted. The transition resistance of a line interruption must be higher than 100 kOHM. The verification of resistance can be carried out by any multimeter.

Note:

The switching with button 4 from "LEVEL I" to "LEVEL III" the sensitivity of Distance is increased up to factor 5.

Setup: manual mode, minimal sensitivity. Tracing depth max. 2 meters.

3.7 Error detection for a electrical floor heating (one-pole application)

The connection conditions:

- If a shield mat or shield wiring is located above the heating wires, no ground connection may exist. If required, separate the shield from the ground connection.
- The switching with button 4 from "LEVEL I" to "LEVEL III" the sensitivity of Distance is increased up to a factor of 5.
- A second transmitter is required for this application.
- Setup: manual mode, minimal sensitivity. Tracing depth max. 2 meters.

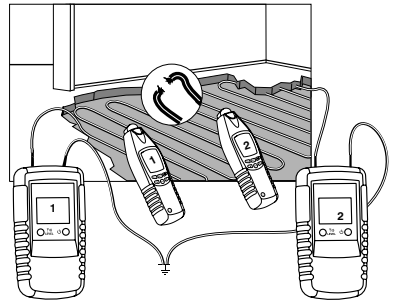

figure 7

3.8 Locating of bottlenecks (obstructions) in installation pipes (single-pole application)

When locating of bottlenecks in installation pipes, Any circuits in the pipe must be dead and grounded; Connect transmitter to the metal coil and auxiliary ground according to figure 8; and Carry out this example as described in the application example.

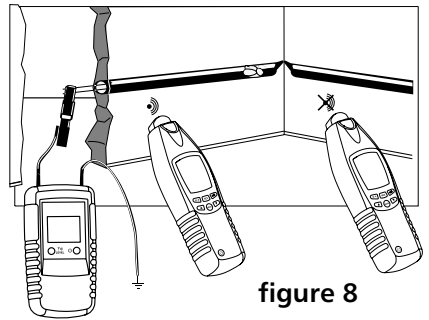

figure 8

Note:

If you have only coil actual of non conducting material (ex. fiber), we recommend you to slide a copper wire ex. 1.5mm² up to the x-pipes.

The switching with button 4 from "LEVEL I" to "LEVEL III" the sensitivity of Distance is increased up to a factor of 5.

Setup: manual mode, minimal sensitivity. Tracing depth max. 2 meters.

3.9 Locating Fuses (dual-pole application)

⚠ When connecting in live circuits, the safety directions must absolutely be respected.

Insert into the current circuit of a multifamily residential structure within a socket between L1 and N and switch the transmitter to "LEVEL I".

You may assign the signal in the secondary distribution and main distribution by transmitter pre-setting "LEVEL I". Thus, fuses and automatic devices can definitely be assigned to a certain current circuit. The detection or assignment of the fuse strongly depends on the wiring realised within the distribution. To obtain a result as precise as possible, the cover should be removed and the supply line to the fuse should be traced.

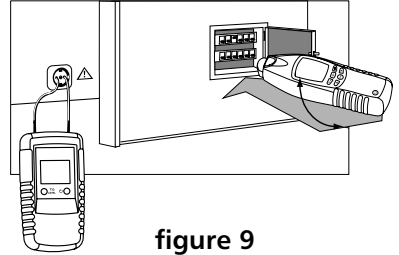

figure 9

Note: Set transmitter to LEVEL I

The switching with button 4 from "LEVEL I" to "LEVEL III" the sensitivity of Distance is increased up to a factor of 5.

Setup: selective mode, minimal sensitivity

Safety cut-outs of different manufacturers have different installation positions for magnetic coils. If no evident signal can be found by the receiver in the position shown below it is advised to modify the position by 90° towards the left or the right.

3.10 Locating of short-circuits in conductors (double-pole application)

When locating of short-circuits in conductors, any existing circuits within the cable must be voltage-free; connect transmitter in accordance with Figure 10; and carry out this example as described in the application example.

Note that the tracing depth for sheathed cable and conductors are different due to the fact that the individual leads in the sheathed cable are twisted around themselves. Usually, short-circuits can only be correctly detected when the short-circuit resistance is lower than 20 Ohm. The verification of the short-circuit resistance can be carried out with any multimeter.

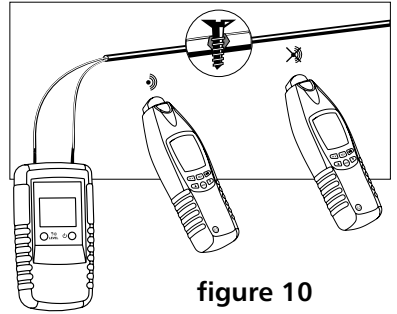

figure 10

Should the short-circuit resistance amount to more than 20 Ohm, you can try the experiment to detect the error location by means of the line interruption method. You can try with sufficient energy to determine the error location (low ohmic connection) or to burn it in a way ensuring a line interruption.

Note:

The switching with button 4 from "LEVEL I" to "LEVEL III" the sensitivity of Distance is increased up to a factor of 5.

Setup: manual mode, minimal sensitivity. Tracing depth max. 0,5 meters.

3.11 Tracing installed water and heating pipes (one-pole application)

The tracing conditions: The line to be located must be separated from the equipotential bonding.

⚠ For safety reasons the electrical system must not be live!

Connect transmitter at foundation ground to the ground socket. The second transmitter socket has to be connected to the conductor to be located. Now the feed line can be traced. The switching with button 4 from "LEVEL I" to "LEVEL III" the sensitivity of Distance is increased up to a factor of 5.

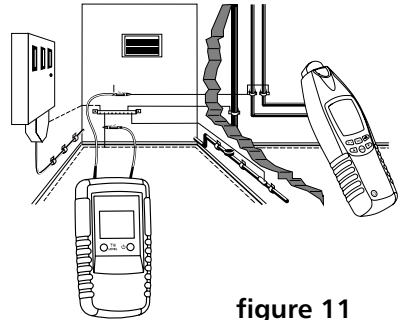

figure 11

Setup: manual mode, minimal sensitivity. Tracing depth max. 2 meters.

3.12 Detecting the direction of water and heating pipes already installed (one-pole application)

When detecting the direction of water and heating pipes already installed, the respective water and heating pipes must be suitably grounded; connect the transmitter according figure 12; and carry out this example as described in the application example.

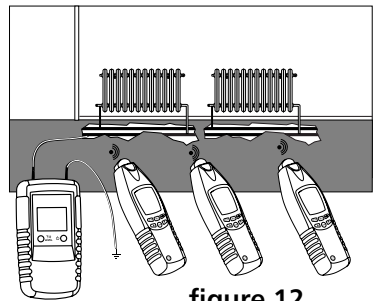

figure 12

Note:

The earth of a properly earthed socket is a suitable ground. The switching with button 4 from "LEVEL I" to "LEVEL III" the sensitivity of Distance is increased up to a factor of 5.

Setup: manual mode, minimal sensitivity. Tracing depth max. 2.5 meters.

3.13 Locating a complete house wiring (one-pole application)

In order to determine all electrical lines of a house within one working process, proceed as follows:

- Remove the bridge in the main distribution between "PE" and "N".
- Connect the transmitter to the system compliance with the figure 13. Now, the neutral conductor, being present within the total system, may be followed.

⚠ For safety reasons, the system must not be live!

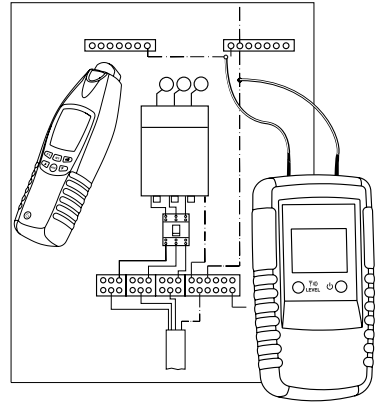

figure 13

Note:

The switching with button 4 from "LEVEL I" to "LEVEL III" the sensitivity of Distance is increased up to a factor of 5.

Setup: manual mode, minimal sensitivity. Tracing depth max. 2 meters.

3.14 Following lines with higher location depth (dual-pole application)

If the dual-pole application is carried out on multi-wire cables, the location depth is widely limited. The reason is that the go-and-return lines are installed very closely. Thus, a strong distortion of the magnetic field occurs. The electro-magnetic field may not develop at the bottleneck. This limitation can easily be eliminated when using a separate conductor to simulate the return line. This separate conductor alllevel is a larger spreading of the electro-magnetic field. Any conductor or cable reel can be used as separate return conductor.

When tracing the conductors, special care has to be taken that the distance between go-and-return-line is larger than the location depth. In practical applications, this amounts to approx. 2.0 meters..

For this application, humid walls, plaster, etc.have only an insignificant influence on the location depth

- The current circuit must not be live.
- Connect the transmitter in compliance with the figure 14.
- The distance between go-and-return line must be minimum 2.0 meters to 2.5 meters or more.
- Proceed as described in the application example.

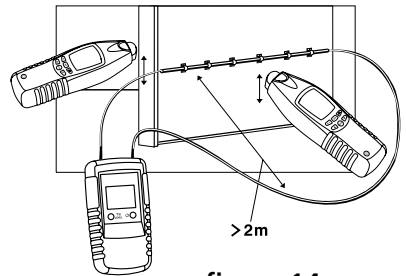

figure 14

Note:

The switching with button 4 from "LEVEL I" to > 2m "LEVEL III" the sensitivity of Distance is increased up to a factor of 5.

Setup: manual mode, minimal sensitivity. Tracing depth max. 2.5 meters.

3.15 Tracing Conductors Within the soil (single-pole application)

The connection is realised in compliance with Figure 15.

⚠ Ensure that the current circuit is not live.

Make sure that the distance between the connection to the ground and the conductor to be detected is high. If the distance is too close, no definite assignment of the signal received can be made to one conductor.

The tracing depth amounts to maximum 2 meters. Furthermore, the tracing depth strongly depends on the soil characteristics.

- Set the receiver to automatic mode.
- Now, search or trace the conductor by means of the signal intensity displayed. When circling the receiver slowly across the conductor to be searched, the display values change considerably. The display of the maximum signal intensity is performed directly via the conductor.

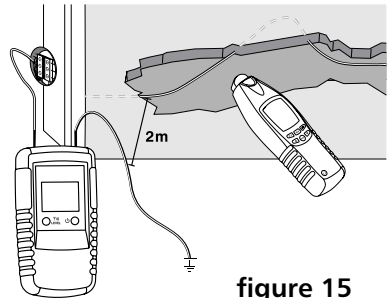

figure 15

The signal intensity level decreases with increasing distance of the fed-in signal (transmitter).

3.16 The reach will be improved when seeking the tension

If the transmitter is attached at the phase and the neutral coil directly gets lost the signal in the line going parallel to and back (see figure).

- The range can partly lead to signal fall off when twisting the conductors among each other. The reach is max. 0.5 meters.

To turn the effect pointed in the upper figure off, the connection should be carried out like the figure 17. The backline is produced about a separate cable. The distance in voltage circuits will be up to 2.5 meters. Back coils at higher distance i.e. Cabletrace (see figure)

- Respect sufficient distance to the conductor to be located in order to allow an unambiguous as-signment between the signals received and the conductor.
- Comply with the safety references when performing connections on live circuits!
- The switching with button 4 from "LEVEL I" to "LEVEL III" the sensitivity of Distance is increased up to a factor of 5.

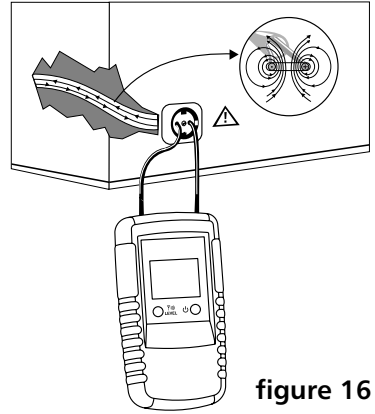

figure 16

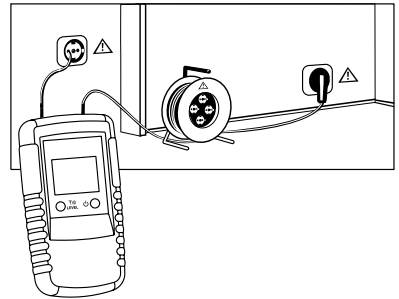

figure 17

3.17 Sorting or determination of conductors already installed (double-pole application)

When sorting or determination of conductors already installed, any existing circuits within the cable must be voltage-free; the lead terminals must be twisted and electrically connected between each other; you need several transmitters, with different transmitter signals (1 to 7); connect the transmitter according to figure 18; and carry out this example as described in the application example.

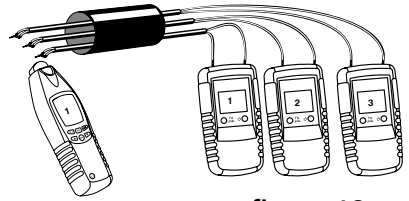

figure 18

For this application example, please pay attention that the stripped lead terminals are twisted with each other. The electrical connection between the stripped lead terminals must be good.

In case only one transmitter is available, the sorting of the sheathed cables can be carried out by sequentially reconnection the transmitter.

The switching with button 4 from "LEVEL I" to "LEVEL III" the sensitivity of Distance is increased up to a factor of 5.

3.18 Mains Voltage Detection Locating Line Interruptions

- No transmitter is required for this application.
- Set the receiver to the "Mains voltage detection" mode.

The bargraph display indicating the signal intensity and the signal sound frequency depends on the level of the voltage to be tested and the distance to the live conductor. The higher the frequency, the higher the voltage, or the lower the distance to the conductor.

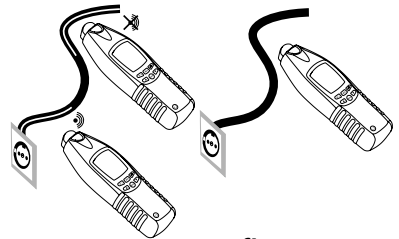

figure 19

Different signal intensities do not allow any assumptions regarding type and intensity of the voltage present. A definite statement regarding the voltage present may only be made when using a measurement instrument equipped with a display.

When testing mains connection cables for interruptions, make sure that both conductors are connected once to the phase (turn mains plug by 180°).

3.19 Setting the Codes (Transmitter)

- Make sure that the meter is switched off before setting the codes.
- Press the sensitive key continually, then press Power key to turn on the meter.
- Press the sensitive key to select the code you want, such as 1-7.
- After setting and turn off the meter, turn on the meter again, the meter is now ready for use.
- Code selection can be made as follows (1,2,3,4,5,6,7).

3.20 Important Application

For our example, we advise you to take a piece of a plastic-sheathed cable, for example. Provisionally install 5m of this cable along the wall with nail clips at eye level as surface mounting. Make sure that the wall is accessible from both sides. Create an artificial interruption at a distance of 1.5m before the line terminal. The line terminals must be open. Strip the interrupted lead at the lead at the start of the light plastic-sheathed cable and connect it via the measuring leads (supplied with the instrument) with (1) terminal of the transmitter.

Connect terminal (2) of the transmitter to a suitable ground. All other cable leads must also be connected to the transmitter and the same ground.

Switch in the transmitter via push button (5). Set the transmitter to "LEVEL I" via button (4). The transmitter function is indicated via the flashing of the signal lamp (3). During the manufacture process, the transmitter has been programmed to display the letter "7". Change the Code via Jumper (7).

Switch, on the receiver via pushbutton (10). All segments are indicated on the display (3) for a short period of time. This indicates that the receiver is functional and that the batteries are full. When switching on the receiver, the instrument is automatically set to "Automatic Mode". To change the sensitivity press the button 6 or 9. Now, the "Manual Mode" is activated. The sensitivity range comprises 8 levels. The respective sensitivity level, between 1 and 8, is changed and briefly displayed (3) by pressing buttons (6 or 9). If a selective and position-de-pendant search has to be performed select the selective mode by pressing the button 7 MODE.

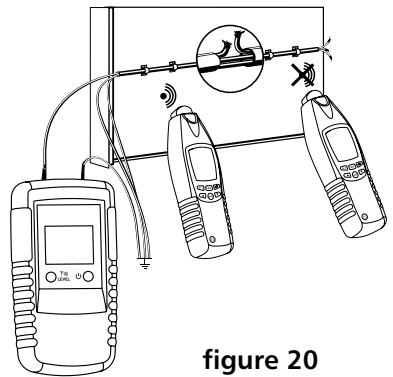

figure 20

Now touch the light-plastic sheathed cable with your receiver just before the location of the interruption. With button (6 or 9) "SENSE" set the sensitivity level so as to just receive the "7" signal. The signal strength is indicated via the bargraph (3). The display indicates the signal sent. Together with this optical indication, an acoustic signal is also emitted from the receiver. If the signal strength increases further, the bargraph (3) is illuminated one after the other in accordance with the signal strength.

Now, using the lowest possible sensitivity level of the receiver, move along the cable and past the interruption. The signal "7" is not displayed any longer and the acoustic signal is not audible any more. Repeat the same experiment on the other side of the wall.

For this, set the transmitter to "Level III" using switch 4. Thus, the range increases by a factor 5.

To perform the test, it is good to mark the location of the artificial interruption on the opposite side of the wall. Select the sensitivity using button (6 or 9) to make sure that the signal "7" is only just receivable. Trace the signal in the wall with the receiver until it is no longer indicated. Localize the artificial interruption by systematically adjusting the sensitivity.

Note:

The switching with button 4 from LEVEL I to LEVEL III the sensitivity of the Distance is increased up to factor 5.

4 Measurement Point Illumination

Press button flashlight button for measurement point illumination. The instrument switches off automatically after approximately 60 seconds or it can be switched off manually when pressing the flashlight button again.

5 Maintenance

When using the instrument in compliance with the Users Manual, no special maintenance is required. For any queries regarding the instrument, please always quote product designation and serial number, both marked on the type shield label on instrument rear. If functional errors occur after expiration of warranty, our after sales service will repair your instrument without delay.

6 Battery Replacement

Receiver batteries have to be changed, when the symbols are vacant“”displayed.

Transmitter batteries have to be changed, when the symbols are displayed.

- Disconnect the instrument from the mains and switch them off.
- Open and remove battery case cover on instrument rear.
- Remove used batteries
- Insert new batteries by respecting the polarity
- Close battery case
- The instrument is now operational.

Note:

- ⚠ Prior to storage battery replacement, disconnect the instrument from any connected test leads.
- ⚠ Reverse polarity of batteries may destroy the instrument. Furthermore, they may explode or ignite
- ⚠ Only use batteries as described in the technical data section!
(One 9V battery , NEDA 1604, IE6F22.Power).
- ⚠ Never try to make contact between both battery cell poles, for example by using a wire connection. The resulting short-circuit current is very high and causes extreme heat. Danger of fire and explosion !
- ⚠ Please consider your environment when you dispose of your one-way batteries or accumulators. They belong in a trash for hazardous waste. In most cases, the batteries can be returned to their point of sale. Please, comply with the respective valid regulation regarding the return, recycling and disposal of used batteries and accumulators.
- ⚠ If an instrument is not used over an extended time period, the batteries must be removed. Should the instrument be contaminated by leaking battery cells, the instrument has to be returned for cleaning and inspection to the factory.

