

INSTRUCTION MANUAL

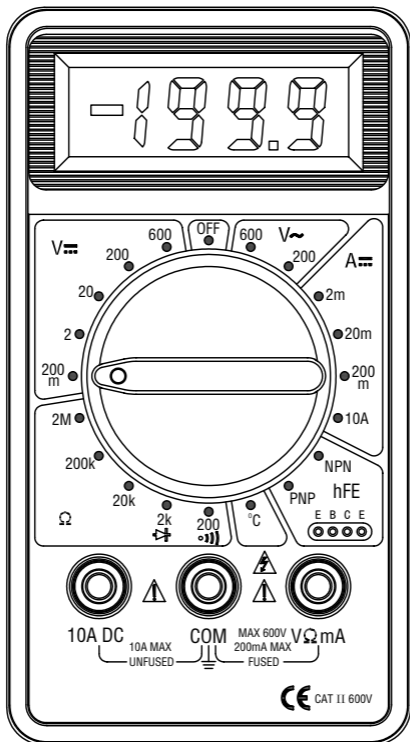

DIGITAL MULTIMETER



Thanks for buying our products, please go through the instruction manual before starting to use the meter, and carefully follow these safety rules.

GENERAL

This series are a series of compact pocket-sized 3¹/₂ digit multimeter for measuring DC and AC voltage, DC and AC current, resistance, temperature, transistor measurement, diode and audible continuity test function. Full range overload protection and low battery voltage indication are provided. They are ideal instruments for use in fields, such as laboratory, workshop, hobby and home applications.

DCV	√	√	√
ACV	√	√	√
DCA	√	√	√
Ω	√	√	√
	√	√	√
		√	√
h_{FE}	√	√	√
			√
Temp		√	

SAFETY WARNINGS

This instrument has been designed, manufactured and tested according to the following standards.

EN 61010-1 : 2001 over voltage CAT II 600V

EN 61010-2-031 : 1995

EN 61000-4-2 (3) : 2001 (2002)

Safety symbols:

“” exists high voltage

“” GND

“” dual insulation

“” must refer to manual

“” low battery

This instruction manual contains warnings and safety rules which must be observed by the user to ensure safe operation of the instrument and retain it in safe condition. Therefore, read through these operating instructions before using the instrument.

 **DANGER** is reserved for the conditions and actions that are likely to cause serious or fatal injury.

 **WARNING** is reserved for the conditions and actions that can cause serious or fatal injury.

 **CAUTION** is reserved for the conditions and actions that can cause injury or instrument damage.

DANGER

- Never make measurement on the circuit in which electrical potential to ground over 500V AC/DC exists.
- Do not attempt to make measurement in the presence of flammable gasses. Otherwise, the use of the instrument may cause sparking, which can lead to an explosion.
- Be sure to keep your fingers behind the finger barrier part of test lead.
- Never attempt to use the instrument if its surface or your hand is wet.
- Do not open the instrument case when making measurement.

 **WARNING**

- Never attempt to make any measurement if any abnormal conditions are noted, such as broken case, cracked test leads and exposed metal parts.
- Do not turn the function selector switch with test leads connected to the instrument.
- Do not install substitute parts or make any modification to the instrument.
- Do not try to replace the batteries if the surface of the instrument is wet.
- Make sure to disconnect test leads from the device under test when opening the case for battery replacement.

 **CAUTION**

- Always make sure to check function switch is setting to the appropriate range before starting measurement.
- Do not expose the instrument to the direct sun, high temperature and humidity or dewfall.
- When the instrument will not be in use for a long period, place it in storage after removing the batteries.
- Use a cloth dipped in water or neutral detergent for cleaning the instrument. Do not use abrasives or solvents.

FRONT PANEL DESCRIPTION

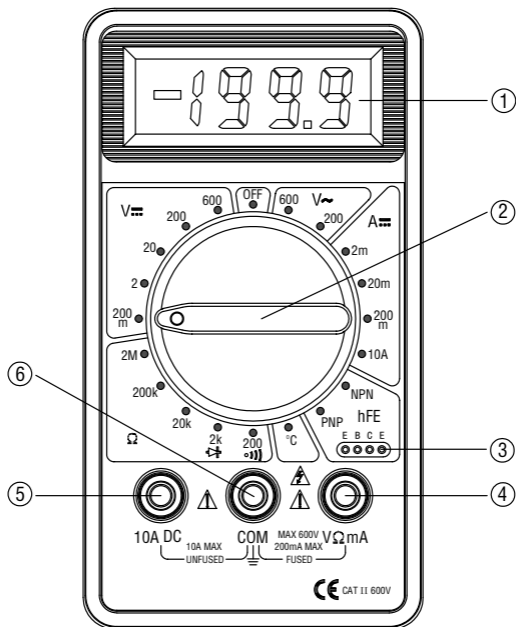

1. DISPLAY

3¹/₂ digit, 7 segment, 12.5mm high LCD.

2. FUNCTION AND RANGE SWITCH

This switch is used to select the function and desired range as well as to turn on the instrument.

To extend the life of battery, the switch should be in the “OFF” position when the instrument is not in use.

3. Transistor measurement socket

4. "VΩmA" Input terminal

Plug in connector for red (positive) test lead for all voltage and resistance and current (except 10A) measurements.

5. "10A" Input Terminal

Plug in connector for red (positive) test lead for 10A measurements.

6. "Common" Input terminal

Plug in connector for black (negative) lead.

GENERAL CHARACTERISTICS

Display 3 1/2 digit LCD with Max. display 1999.

Polarity Auto polarization

Measurement speed: Updates 2~3 times /second.

Battery 9V, NEDA 1604 or 6F22 or 006P

Storage -15°C ~ 50°C

Size 128(D) × 70(W) × 34(H)mm.

Weight 137g

Low volt left side of LCD will show  symbol

Working temperature : 0 ~ 40°C, relative humidity : < 75%

Over range maximum display "1" or "-1"

TECHNICAL SPECIFICATIONS

Accuracies are guaranteed for 1 year, 23 ± 5°C, less than 75% RH.

DC VOLTAGE

Range	Resolution	Accuracy
200mV	100μV	±(0.5% rdg + 2 dgt)
2V	1mV	±(0.8% rdg + 3 dgt)
20V	10mV	±(0.8% rdg + 3 dgt)
200V	100mV	±(0.8% rdg + 3 dgt)
600V	1V	±(0.8% rdg + 5 dgt)

Overload protection : 220V rms AC for 200mV range and 600V DC or 600V rms AC for other ranges.

DC CURRENT

Range	Resolution	Accuracy
200 μ A	0.1 μ A	$\pm(1\% \text{ rdg} + 2 \text{ dgt})$
2mA	1 μ A	$\pm(1\% \text{ rdg} + 2 \text{ dgt})$
20mA	10 μ A	$\pm(1\% \text{ rdg} + 2 \text{ dgt})$
200mA	100 μ A	$\pm(1.2\% \text{ rdg} + 2 \text{ dgt})$
10A	10mA	$\pm(2\% \text{ rdg} + 2 \text{ dgt})$

Overload protection : 200mA / 250V fuse

Measuring voltage drop : 200mV

AC VOLTAGE

Range	Resolution	Accuracy
200V	100mV	$\pm(2\% \text{ rdg} + 2 \text{ dgt})$
600V	1V	$\pm(2\% \text{ rdg} + 2 \text{ dgt})$

Overload protection : 600V DC or 600V rms AC

Response : Average responding, calibrated in rms of a sine wave.

Frequency range : 40 ~ 400Hz

RESISTANCE

Range	Resolution	Accuracy
200 Ω	0.1 Ω	$\pm(0.8\% \text{ rdg} + 5 \text{ dgt})$
2k Ω	1 Ω	$\pm(0.8\% \text{ rdg} + 2 \text{ dgt})$
20k Ω	10 Ω	$\pm(0.8\% \text{ rdg} + 2 \text{ dgt})$
200k Ω	100 Ω	$\pm(0.8\% \text{ rdg} + 2 \text{ dgt})$
2M Ω	1k Ω	$\pm(1.2\% \text{ rdg} + 3 \text{ dgt})$

Maximum open circuit voltage : 2.8V

Overload protection : 10 seconds max. 220V rms

TEMPERATURE (K TYPE)

Range	Resolution	Accuracy
-40 ~ 1000 $^{\circ}$ C	1 $^{\circ}$ C	$\pm(1\% \text{ rdg} + 3 \text{ dgt})(\text{up to } 400^{\circ}\text{C})$ $\pm(2\% \text{ rdg} + 3 \text{ dgt})(\text{over } 400^{\circ}\text{C})$

Overload Protection : 220V rms AC

Diode Test

RANGE	DESCRIPTION
	Display voltage drop approximation

CONTINUITY

RANGE	DESCRIPTION
	Built-in buzzer sounds if resistance is less than 70 Ω

Overload protection : 10 seconds max. 220V rms

Transistor h_{FE} measurement

Range	Displaying range	Test condition
h_{FE} (NPN or PNP)	0~1000	Basic current is approx. 10 μ A, V_{ce} is approx. 3V

OPERATING INSTRUCTIONS

DC VOLTAGE MEASUREMENT

1. Connect red test lead to "V Ω mA", black test lead to "COM" jack.
2. Set the rotary switch to DC V position. If the voltage to be measured is not known beforehand, set switch to the highest range and reduce it until satisfactory reading is obtained.
3. Connect test leads to device or circuit being measured.
4. Turn on power of the device or circuit being measured, voltage value will appear on digital display along with the voltage polarity.

AC VOLTAGE MEASUREMENT

1. Red test lead to "V Ω mA", black lead to "COM".
2. Set the range switch to AC V position.

3. Connect test leads to device or circuit.
4. Read voltage value on digital display.

DC CURRENT MEASUREMENT

1. Red test lead to "V Ω mA", black lead to "COM" (For measurements between 200mA and 10A connect red lead to "10A" jack with fully depressed)
2. Set the range switch to DC A position.
3. Open the circuit to be measured and connect test leads IN SERIES with the load in which current is to be measured.
4. Read current value on digital display.

RESISTANCE MEASUREMENT

1. Red test lead to "V Ω mA", Black lead to "COM".
2. Set the range switch to Ω position.
3. If the resistance being measured is connected to a circuit, turn off power and discharge all capacitors before measurement.
4. Connect test leads to circuit being measured.
5. Read resistance value on digital display.

TEMPERATURE MEASUREMENT

1. Set the range switch to "°C" position.
2. Insert the black plug of thermocouple into "COM" terminals and the red plug to "V Ω mA" terminals, put working end into measurement place.
3. The display will read the temperature value °C.

TEST SIGNAL USE

1. Set the range switch to \overline{V} position.
2. Test signal (50Hz) appears between "V Ω mA" and "COM" jacks. The output voltage is approx 5V p-p with 50k ohm impedance.

DIODE MEASUREMENT

1. Red test lead to “VΩmA”, black lead to “COM”.
2. Set the range switch to  position.
3. Connect the red test lead to the anode of the diode to be measured and black test lead to cathode.
4. The forward voltage drop in mV will be displayed. If the diode is reversed, figure “1” will be shown.

AUDIBLE CONTINUITY TEST

1. Red test lead to “VΩmA”, black lead to “COM”.
2. Set the range switch to  position.
3. Connect test leads to two points of circuit to be tested, if the resistance is lower than 70Ω, buzzer will sound.

TRANSISTOR h_{FE} MEASUREMENT

1. Set the rotary switch to NPN or PNP range;
2. NPN or PNP type transistor will be inserted into the E, B, C socket.
3. Read resistance value on digital display.

BATTERY AND FUSE REPLACEMENT

Fuse rarely need replacement and blow almost always as a result of operator error.

If  appears on display, it indicates that the battery should be replaced.

To replace battery & Fuse (200mA / 250V) remove the 2 screws in the bottom of the case. Simply remove the old and replace with a new one. Be careful to observe polarity.

CAUTION

Before attempting to open the case of the instrument, be sure to disconnect test leads from any energized circuits to avoid shock hazard.